

Flameproof Multitone Hooter



	SALIENT FEATURES
Aux. Supply	230 VAC OR 110VAC OR 24VDC (Select any one)
Power Consumption	1000mA @ 24 VDC & 200mA @ 230 VAC
Multitone	32 tones
Sound level	105 to 110 dB
Operating Temp.	Up to 55°C
Humidity	90% at 40°C
Enclosure	Lm6, Aluminum
Weather Protection	IP 65
Coating	Powder coated
Dimension	As per drawing
Applications	Hazardous area
Gas group	IIA, IIB & IIC, Zone 1 & Zone 2
Weight	9 Kg Max
Terminals	Up to 2.5 Sqmm
Cable Entry	3/4" NPT OR 1/2" NPT OR M20 (select any one)
Mounting	Wall mounting / slab mounting type

Flameproof Instrumentation

Plot. No. E/14, Addl. MIDC, Anand Nagar, Ambarnath (E), Dist. Thane, Maharashtra, India — 421 506.,

sales@flameproof.co.in

9321160178

www.flameproof.co.in

Dimensional Details

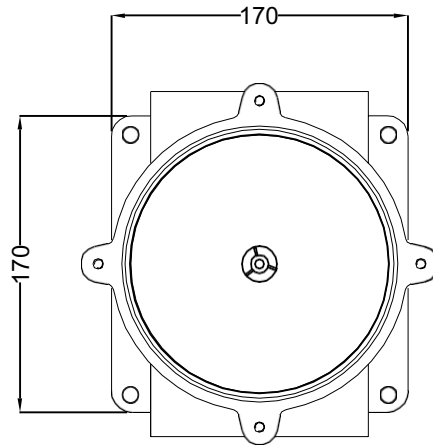

TOP VIEW

$\text{Ø}156 \pm 2$

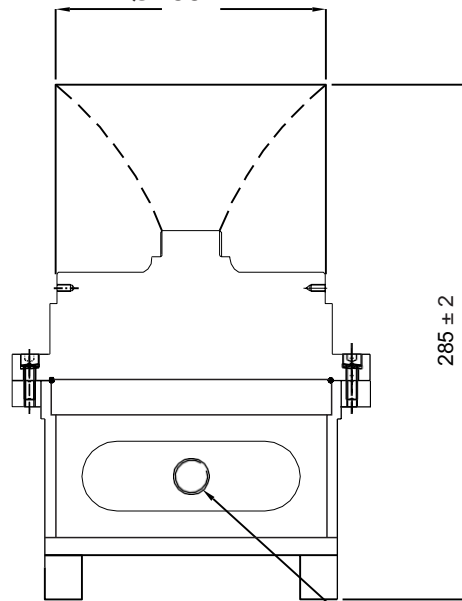

SIDE VIEW

**CABLE
ENTRY**

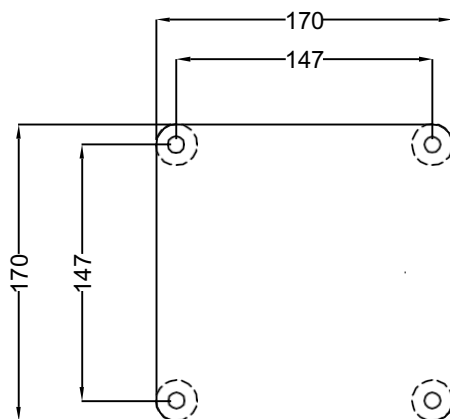

**BACK VIEW
MOUNTING DIMENSION**

All dimensions are in mm



Flameproof Instrumentation

Made in



Flameproof Instrumentation

Plot. No. E/14, Addl. MIDC, Anand Nagar, Ambarnath (E), Dist. Thane, Maharashtra, India — 421 506.,





































sales@flameproof.co.in

9321160178



www.flameproof.co.in

TONE SELECTION CHART

								
1		11111		800 & 970Hz	2Hz (250ms~250ms)	BS Fire Tone		
2		11110		800 & 970Hz	7Hz (7/s)	BS Fire Tone		
3		11101		800 & 970Hz	1Hz (1/s)	BS Fire Tone		
4		11100		2850Hz	Steady	General Purpose		
5		11011		2400 ~ 2850Hz	7Hz	General Purpose		
6		11010		2400 ~ 2850Hz	1Hz	General Purpose		
7		11001		500 ~ 1200Hz	3s Sweep, 0.5s silence, then repeat	Dutch fire (NEN 2575)		
8		11000		1200 ~ 500Hz	1Hz	German fire (DIN 33 404)		
9		10111		2400 & 2850Hz	2Hz (250ms~250ms)	General Purpose		
10		10110		970Hz	0.5Hz (1s On / 1s Off)	PFEER alert		
11		10101		800 & 970Hz	1Hz (500ms~500ms)	BS Fire Tone		
12		10100		2850Hz	0.5Hz (1s On / 1s Off)	General Purpose		
13		10011		970Hz	0.8Hz (250ms On / 1s Off)	General Purpose		
14		10010		970Hz	Steady	PFEER toxic gas		
15		10001		554 & 440Hz	100ms ~ 400ms	French fire (NFS 32-001)		
16		10000		660Hz	3.3Hz (150ms On / 150ms Off)	Swedish (Air Raid)		
17		01111		660Hz	0.28Hz (1.8s On / 1.8s Off)	Swedish (Local warning)		
18		01110		660Hz	0.05Hz (13s Off / 6.5Hz On)	Swedish (Pre-mess)		
19		01101		660Hz	Steady	Swedish (All Clear)		
20		01100		554 & 440Hz	0.5Hz (1s On / 1s Off)	Swedish (Turn Out)		
21		01011		660Hz	1Hz (500ms ~ 500ms)	Swedish General Purpose		
22		01010		2850Hz	4Hz (150ms On / 100ms Off)	Pelican Crossing		
23		01001		800 ~ 970Hz	50Hz	BS Fire Tone		
24		01000		2400 ~ 2850Hz	50Hz	General Purpose		
25		00111		970Hz	3 x 500ms pulses followed by 1.5s silence then repeat	ISO 8201		
26		00110		800 ~ 970Hz	3 x 500ms pulsed sweep followed by 1.5s silence then repeat	ISO 8201		
27		00101		970 & 800Hz	3 x 500ms pulsed two tone followed by 1.5s silence then repeat	ISO 8201		
28		00100		800 & 970Hz	2Hz (250ms ~ 250ms)	BS Fire Tone		
29		00011		990 & 650Hz	2Hz (250ms ~ 250ms) (Symphoni Tones)	BS Fire Tone		
30		00010		510 & 610Hz	2Hz (250ms ~ 250ms) (Squashni Micro Tones)	BS Fire Tone		
31		00001		300 ~ 1200Hz	1Hz	General Purpose		
32		00000		510 & 610Hz	1Hz Alternating (500ms ~ 500ms)	BS Fire		



Flameproof Instrumentation



Made in India