

# Flameproof Multitone Hooter with Flasher



	SALIENT FEATURES
Aux. Supply	230 VAC OR 110VAC OR 24VDC (select any one)
Power Consumption	1000mA @ 24 VDC & 200mA @ 230 VAC
Multitone	32 tones
Sound level	105 to 110 dB
Flasher	LED type
Flasher Candelas	12 Candelas
Flashing Rate	60 Flashes per minute
Operating Temp.	Up to 55°C
Enclosure	Lm6, Aluminum
Weather Protection	IP 65
Coating	Powder coated
Dimension	As per drawing
Applications	Hazardous area
Gas group	IIA, IIB & IIC, Zone 1 & Zone 2
Weight	9 Kg Max
Terminals	Up to 2.5 Sqmm
Cable Entry	1/2" NPT OR 3/4" NPT OR M20 (select any one)
Mounting	Wall mounting / slab mounting type

## Flameproof Instrumentation

Plot. No. E/14, Addl. MIDC, Anand Nagar, Ambarnath (E), Dist. Thane, Maharashtra, India — 421 506.,

sales@flameproof.co.in

9321160178

www.flameproof.co.in

# Dimensional Details

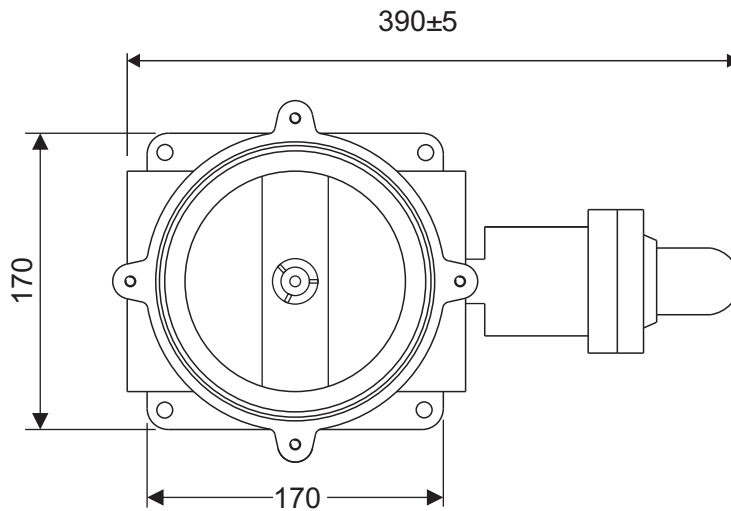

**TOP VIEW**

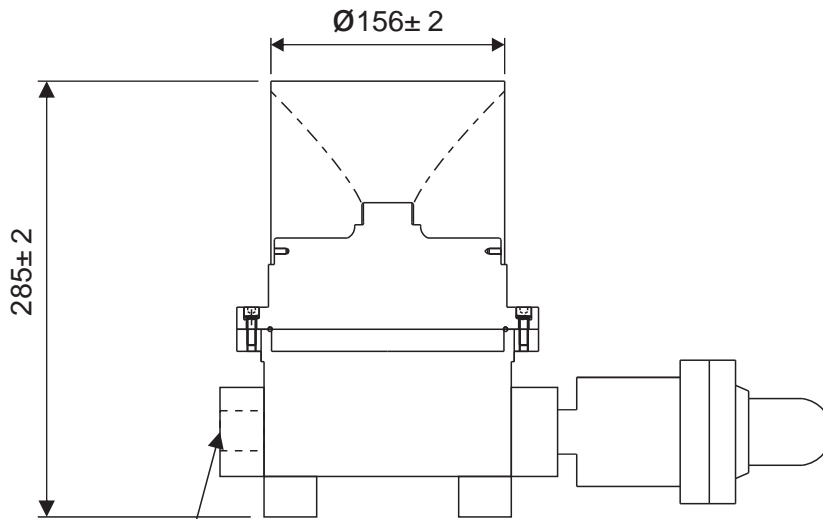

**FRONT VIEW**

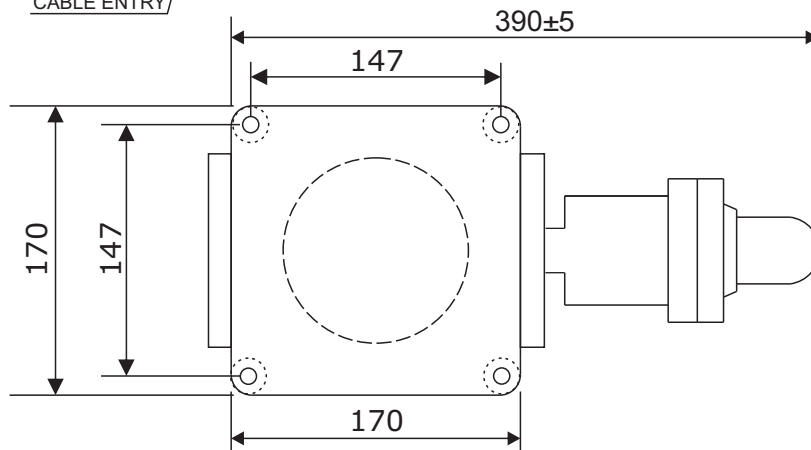

**BACK VIEW**

**MOUNTING DIMENSIONS**

All dimensions are in mm



Flameproof Instrumentation

Made in



Flameproof Instrumentation





































Plot. No. E/14, Addl. MIDC, Anand Nagar, Ambarnath (E), Dist. Thane, Maharashtra, India — 421 506.,

sales@flameproof.co.in

9321160178

www.flameproof.co.in

# tone selection chart

							
1		11111		800 & 970Hz	2Hz (250ms~250ms)	BS Fire Tone	
2		11110		800 & 970Hz	7Hz (7/s)	BS Fire Tone	
3		11101		800 & 970Hz	1Hz (1/s)	BS Fire Tone	
4		11100		2850Hz	Steady	General Purpose	
5		11011		2400 ~ 2850Hz	7Hz	General Purpose	
6		11010		2400 ~ 2850Hz	1Hz	General Purpose	
7		11001		500 ~ 1200Hz	3s Sweep, 0.5s silence, then repeat	Dutch fire (NEN 2575)	
8		11000		1200 ~ 500Hz	1Hz	German fire (DIN 33 404)	
9		10111		2400 & 2850Hz	2Hz (250ms~250ms)	General Purpose	
10		10110		970Hz	0.5Hz (1s On / 1s Off)	PFEER alert	
11		10101		800 & 970Hz	1Hz (500ms~500ms)	BS Fire Tone	
12		10100		2850Hz	0.5Hz (1s On / 1s Off)	General Purpose	
13		10011		970Hz	0.8Hz (250ms On / 1s Off)	General Purpose	
14		10010		970Hz	Steady	PFEER toxic gas	
15		10001		554 & 440Hz	100ms ~ 400ms	French fire (NFS 32-001)	
16		10000		660Hz	3.3Hz (150ms On / 150ms Off)	Swedish (Air Raid)	
17		01111		660Hz	0.28Hz (1.8s On / 1.8s Off)	Swedish (Local warning)	
18		01110		660Hz	0.05Hz (13s Off / 6.5Hz On)	Swedish (Pre-mess)	
19		01101		660Hz	Steady	Swedish (All Clear)	
20		01100		554 & 440Hz	0.5Hz (1s On / 1s Off)	Swedish (Turn Out)	
21		01011		660Hz	1Hz (500ms ~ 500ms)	Swedish General Purpose	
22		01010		2850Hz	4Hz (150ms On / 100ms Off)	Pelican Crossing	
23		01001		800 ~ 970Hz	50Hz	BS Fire Tone	
24		01000		2400 ~ 2850Hz	50Hz	General Purpose	
25		00111		970Hz	3 x 500ms pulses followed by 1.5s silence then repeat	ISO 8201	
26		00110		800 ~ 970Hz	3 x 500ms pulsed sweep followed by 1.5s silence then repeat	ISO 8201	
27		00101		970 & 800Hz	3 x 500ms pulsed two tone followed by 1.5s silence then repeat	ISO 8201	
28		00100		800 & 970Hz	2Hz (250ms ~ 250ms)	BS Fire Tone	
29		00011		990 & 650Hz	2Hz (250ms ~ 250ms) (Symphoni Tones)	BS Fire Tone	
30		00010		510 & 610Hz	2Hz (250ms ~ 250ms) (Squashni Micro Tones)	BS Fire Tone	
31		00001		300 ~ 1200Hz	1Hz	General Purpose	
32		00000		510 & 610Hz	1Hz Alternating (500ms ~ 500ms)	BS Fire	



Flameproof Instrumentation



Made in India